

Splinting Equipment

Ferno Model 108-A Pole Stretcher

Features heavy-duty aluminum poles for easy handling. Rugged aluminum cross spreaders and feet are standard. Available in 81" or 90" lengths. *Order Model 384-C Fabric Combination Carrying/Wall Case for the 81" length, and Model 384-D for the 90" length.*

STANDARD FEATURES

- Excellent for hospital or disaster services.
- Heavy-duty, vinyl-coated nylon cover.
- Non-slip hand grips.

SPECIFICATIONS

Length	81" (206 cm)
	90" (229 cm)
Width, open	21½" (55 cm)
closed	4" (11 cm)
Height	5½" (14 cm)
Weight, Model 108-A — 81"	11 lbs. (5 kg)
Model 108-A — 90"	12 lbs. (6 kg)
Load capacity	350 lbs. (159 kg)



Ferno Model 108-AF Pole Stretcher

Can be folded both lengthwise and crosswise to fit in minimum storage space. Available in 81" or 90" lengths. *Order Model 383-B Fabric Combination Carrying/Wall Case for the 81" length, and Model 383-C for the 90" length.*

SPECIFICATIONS

Length, open	81" (206 cm)
	90" (229 cm)
Length, folded	40¼" (103 cm)
	44¾" (114 cm)
Width, open	21½" (55 cm)
folded	9¾" (25 cm)
Height	5¾" (15 cm)
Weight, Model 108-AF — 81"	12 lbs. (6 kg)
Model 108-AF — 90"	13 lbs. (6 kg)
Load capacity	350 lbs. (159 kg)



Ferno Model 108-F Folding Pole Stretcher

Features lightweight aluminum poles and International Orange, Vinyl-coated nylon cover. Can be folded in half lengthwise for easy storage. Storage case included. *Order Model 383-A Fabric Combination Carrying/Wall Case.*

SPECIFICATIONS

Length, open	83½" (213 cm)
folded	41¾" (107 cm)
Width, open	22" (56 cm)
folded	3" (8 cm)
Height	1½" (4 cm)
Weight	8 lbs. (4 kg)
Load capacity	350 lbs. (159 kg)



Ferno Model 108 Pole Stretcher

Non-folding, lightweight aluminum poles. Non-slip hand grips standard. Heavy-duty, vinyl-coated nylon cover in International Orange.

SPECIFICATIONS

Length	83½" (213 cm)
Width	23¼" (60 cm)
Height	1½" (4 cm)
Weight	8 lbs. (4 kg)
Load capacity	350 lbs. (159 kg)

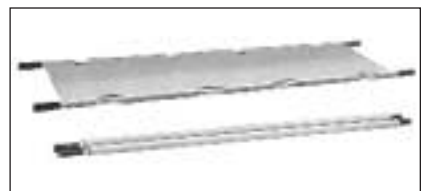

Ferno Model 108-B Breakaway Pole Stretcher

Unique center zipper allows stretcher to be separated and removed from underneath the patient without moving patient. Aluminum poles with hand grips. Makes patient transfers quick and easy. Heavy-duty, vinyl-coated nylon cover in International Orange.

SPECIFICATIONS

Length	83½" (213 cm)
Width	21½" (55 cm)
Height	1½" (4 cm)
Weight	7½ lbs. (3 kg)
Load capacity	350 lbs. (159 kg)

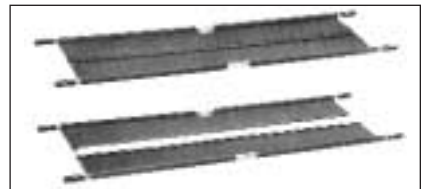

Splinting Equipment

Ferno Model 452 Extrication Collar

Uni-Cellular foam with a permanent vinyl coating. Conforms to the patient's anatomy to provide support. One-piece design with extended side Velcro® closure allows for easy application whether patient is lying on the ground or sitting up. Non-absorbent, resists bloodstains, and is easy to clean. Available as a set of three (small, medium, large) or in individual sizes. International Orange.

Model 452 complete set

(includes one each small, medium, large)

Model 452-S small

Model 452-M medium

Model 452-L large

SPECIFY MODEL NUMBER WHEN ORDERING.

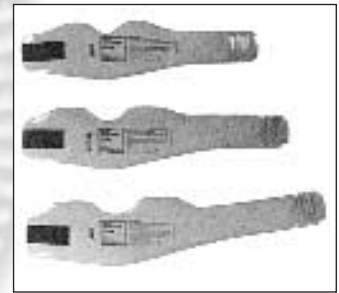

Ferno Model 450 Cervical Collar

A luxury-grade, stockinette-covered foam collar. Four inches wide. Adjustable rear Velcro® closure. Performs well under all temperature extremes and provides lasting comfort for the patient. Hand washable, air dry. Available as a set of three (small, medium, large) or in individual sizes. White only.

Model 450 complete set

(includes one each small, medium, large)

Model 450-S small

Model 450-M medium

Model 450-L large

SPECIFY MODEL NUMBER WHEN ORDERING.

NOTE: This product *not* recommended for emergency or extrication procedures.



Splinting Equipment

Ferno Model 125 Ferno KED (Kendrick Extrication Device)

An improved means of immobilizing and extricating patients. Complete package includes wrap-around jacket, adjustable neck roll, 2 forehead/chin straps, and storage case. All straps are sewn into jacket eliminating the need of having to search for the correct straps. Design permits use as a versatile splinting device for suspected rib fractures, hip fractures, or pelvic fractures. Chest flaps can be folded back to use cardiac monitoring or defibrillation equipment.

STANDARD FEATURES

- Provides horizontal flexibility for ease of application plus vertical rigidity for patient safety.
- Pre-sewn color coded securing straps are instantly ready when needed, out of the way when not needed.
- Immobilizes torso, head, and spine for prompt extrication while minimizing risk of further injury during removal.
- Three lifting handles permit rescuers to get a firm grip on patient for security and control during extrication.
- Does not interfere with advanced life support procedures.
- Easy to X-ray injured patient without removing Ferno KED.
- Adapts for use on small children and pregnant women.
- Stores as one complete compact unit.
- 500 lbs. capacity.

Call or write for detailed specifications.

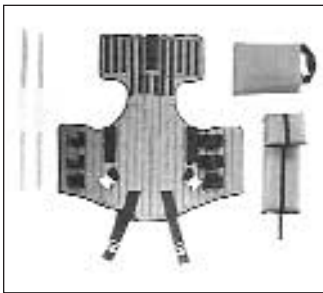

Ferno Model 725 Ferno KED Slide Set

Set includes thirty-six 35 mm, full-color slides that vividly demonstrate the step-by-step extrication procedure, utilizing the Ferno KED. A detailed presentation script is included.

Splinting Equipment

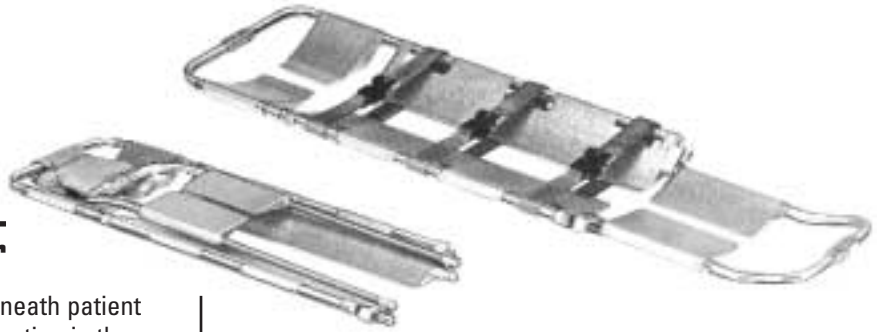

Ferno Model 65 Scoop Stretcher

Enables attendants to place stretcher underneath patient without rolling or lifting the patient. Immobilization in the position found minimizes the risk of complicating the original injury. Open center permits patient to be X-rayed while immobilized on Scoop Stretcher. *Order Model 385-C Fabric Combination Carrying/Wall Case.*

STANDARD FEATURES

- Sturdy, lightweight aluminum construction.
- Adjustable length.
- Easily stores in backboard compartment, under squad bench, or within stair chair cabinet.
- Separates in half during application and removal.
- Three quick-release patient restraints.

SPECIFICATIONS

Length	
minimum extension	66" (168 cm)
maximum extension	79" (201 cm)
folded	47" (120 cm)
Width, coupled	16 ³ / ₄ " (43 cm)
Depth, folded	3 ¹ / ₂ " (9 cm)
Weight	20 lbs. (9 kg)
Load capacity	350 lbs. (159 kg)



Automatic locking length adjustment latches prevent slippage.



Trough-shape design "scoops" underneath patient with a minimum of patient movement.



Lower section easily adjusts to fit each individual patient.



Patented end latch hinge operated by recessed button easily separates or joins the halves of the stretcher.



Model 561 Scoop Stretcher Brackets. These brackets securely mount the Model 65 Scoop Stretcher on an ambulance wall. Bracket Model 561-A accommodates Models 69 and 69-X. Easy installation.



Splinting Equipment

Ferno Model 69 Build-A-Board

Extricate accident victim in seated position with a minimum of movement. Four separate support sections plus adjustable headboard included. The angle of the back section of the Build-A-Board is adjustable to fit the patient in the position found. Restraints included. *Order Model 385-E Fabric Combination Carrying/Wall Case.*

STANDARD FEATURES

- Sturdy, lightweight aluminum construction.
- Separates in half during application and removal, minimizing movement of the injured patient.
- Provides excellent pelvic support.
- Adjustable low-profile headboard.
- Three quick-release patient restraints.

SPECIFICATIONS

(coupled in seated position)

Height	31" (79 cm)
Depth	17 $\frac{1}{2}$ " (45 cm)
Width	16 $\frac{3}{4}$ " (43 cm)
Weight	12 $\frac{1}{2}$ lbs. (6 kg)
Load capacity	350 lbs. (159 kg)

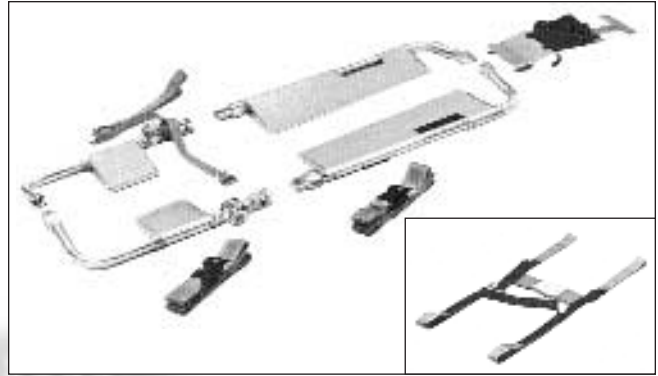

Ferno Model 720 Build-A-Board Slide Set

Forty full-color, 35 mm slides with script detailing the use and application of the Model 69 Build-A-Board.

Ferno Model 69-X Combination Scoop Stretcher, Build-A-Board

The Model 69-X includes above sections of Build-A-Board unit plus an additional lower torso section like that of the Model 65 Scoop Stretcher. To convert Build-A-Board to *Scoop Stretcher*, remove seat section and couple lower torso section directly to back section. *Three patient restraints included. Order Model 559-A Wall Mount Brackets.*

SPECIFICATIONS

Length, minimum extension	65 $\frac{3}{4}$ " (168 cm)
Maximum extension	79 $\frac{1}{4}$ " (202 cm)
Width	16 $\frac{1}{4}$ " (42 cm)
Weight	19 $\frac{1}{4}$ lbs. (9 kg)
Load capacity	350 lbs. (159 kg)

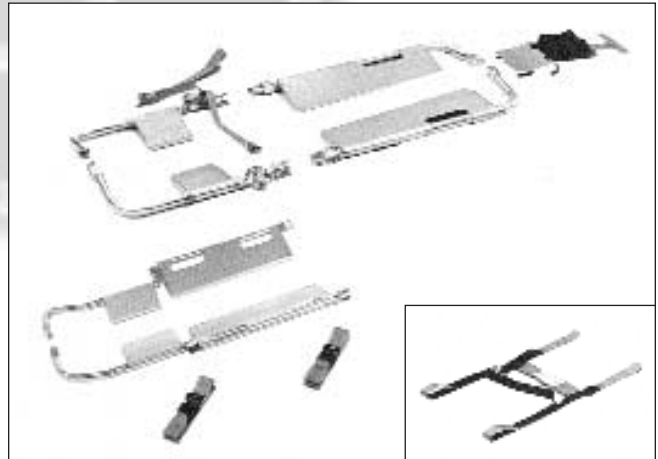

Ferno Model 364 Head Restraint

The Model 364 Head Restraint is designed to be used in conjunction with the Ferno Models 69 and 69-X Build-A-Boards. It consists of a head support piece, forehead anchoring strap, and a chin support strap. The Model 364 Head Restraint simplifies the application of the Build-A-Board to the patient and significantly increases patient immobilization.



Splinting Equipment

Ferno Model 60 Aluminum Long Backboard

For the removal and transport of victims with suspected spinal injury. Folds in half for storage in a variety of ambulance compartments. *Order Model 385-A Fabric Combination Carrying/Wall Case.*

STANDARD FEATURES

- Sturdy, lightweight aluminum construction.
- Convenient handhold locations.
- Three 9' nylon patient restraints.

SPECIFICATIONS

Length, open	72" (183 cm)
Depth, folded	2½" (7 cm)
Width	18" (46 cm)
Height, open	1¼" (4 cm)
folded	36" (92 cm)
Weight	17½ lbs. (8 kg)
Load capacity	350 lbs. (159 kg)



Ferno Model 60-2, 60-4 Aluminum Long Backboards

The Model 60-2 is a combination stretcher and backboard. Designed with specific handholds and openings for cravats or patient restraints. Built with 3 full-width supports mounted on bottom side that provide a 1" space for grasping frame. Model 60-4 is identical but with 78¼" length.

STANDARD FEATURES

- Sturdy, lightweight aluminum construction.
- Folds in half for compact storage.
- Numerous handholds and openings for various strap configurations.

SPECIFICATIONS

Length, open, 60-2	72¼" (184 cm)
open, 60-4	78¼" (199 cm)
Depth, folded	2½" (7 cm)
Width	18" (46 cm)
Height, open	2¼" (6 cm)
folded, 60-2	36¼" (93 cm)
folded, 60-4	39" (100 cm)*
Weight	14 lbs. (6 kg)
Load capacity	350 lbs. (159 kg)

* In upright storage position

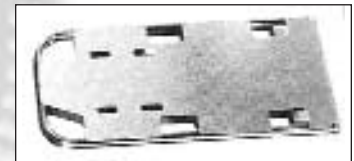

Ferno Model 61 Aluminum Short Backboard

Narrow design allow attendants to use Model 61 Short Backboard in bucket seats and confined areas. Comes complete with adjustable neck roll, 2 forehead/chin straps, 3 color-coded patient restraints, and Velcro® strips. *Order Model 385-B Fabric Combination Carrying/Wall Case.*

STANDARD FEATURES

- Sturdy, lightweight aluminum construction.
- Narrow design for use in small cars.
- Numerous openings for various strap configurations.

SPECIFICATIONS

Length	32" (82 cm)
Width	13" (34 cm)
Depth	1" (3 cm)
Weight	3½ lbs. (2 kg)
Load capacity	350 lbs. (159 kg)

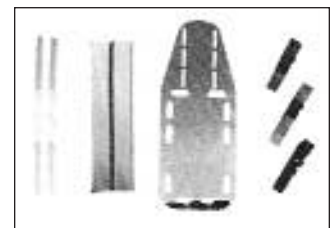

Ferno Model 363 Neck Roll

The Model 363 Neck Roll is designed to be used in conjunction with a wooden short backboard of conventional design. The Model 363 consists of an adjustable neck pad, forehead and chin straps, and Velcro® attachment strips. The Model 363 when used in conjunction with a short backboard will allow quicker, more secure application of the backboard to the patient.

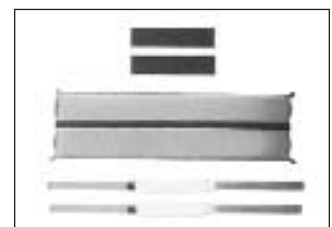

Splinting Equipment

Ferno Models 74, 74R, 76, 76R Wood Backboards

Ferno Model 74 Long Wood Backboard.

Ferno Model 74R Long Wood Backboard with Runners.

Ferno Model 76 Long Wood Backboard with three 9' Patient Restraints.

Ferno Model 76R Long Wood Backboard with Runners and three 9' Patient Restraints.

Constructed of $\frac{3}{4}$ " marine-grade plywood with high quality finish on both sides. All models have predrilled holes for footboard, as well as head-end center hole for rescue use or storage purposes. Available with 9' nylon, quick-release patient restraints.

STANDARD FEATURES

- Tapered design for easy handling.
- Numerous openings for various strap configurations.
- Optional oak runners.

SPECIFICATIONS

Length	72" (183 cm)
Width	15 $\frac{3}{4}$ " (41 cm)
Depth, 74, 76	$\frac{3}{4}$ " (2 cm)
74R, 76R	1 $\frac{1}{2}$ " (4 cm)
Weight	14 lbs. (6 kg)
Load capacity	350 lbs. (159 kg)

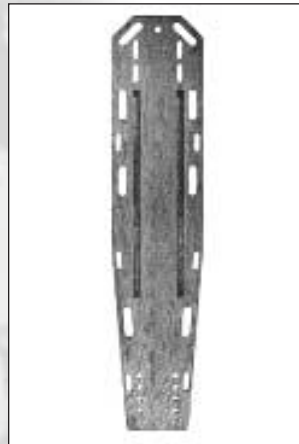
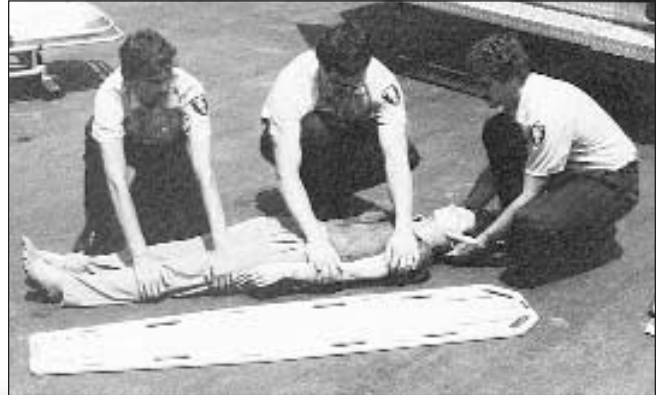

Finger plates on Models 74 and 76 permit easy lifting of board without pinching fingers.

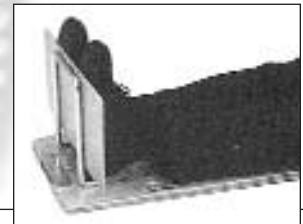

Models 74R and 76R Long Backboards feature strong oak runners.

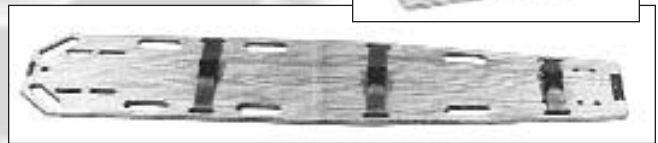

Quick release patient restraints are standard on Models 76 and 76R backboards.

Ferno Models 563 Detachable Foot Support

Attaches securely to Long Wood Backboards. For use in vertical-lift rescues. 10 $\frac{5}{8}$ " H x 14" L (22 cm x 36 cm). Weight: 1 $\frac{1}{2}$ lb. (.7 kg).

Ferno Models 75, 77 Short Wood Backboard

Short backboard permits easy application in small autos or confined areas. Constructed of $\frac{1}{2}$ " 7-ply marine-grade plywood, the Model 75 is extremely strong, yet thin enough to place behind patient with a minimum of movement.

STANDARD FEATURES

- Narrow, thin design.
- Numerous openings for various strap configurations.

SPECIFICATIONS

Length	32" (82 cm)
Width	12 $\frac{3}{4}$ " (33 cm)
Depth	$\frac{1}{2}$ " (2 cm)
Weight	7 $\frac{1}{2}$ lbs. (3 kg)
Load capacity	350 lbs. (159 kg)

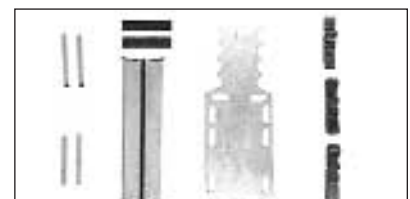
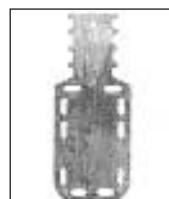

Model 77 includes short backboard, adjustable neck roll, 2 forehead/chin straps, and color-coded patient restraints.

Splinting Equipment

Ferno Model 71 Basket Stretcher

High-density polyethylene shell supported by a permanently attached heavy-duty aluminum frame. Unlike conventional wire basket stretchers, the Model 71 is snag and penetration proof, and won't rust or corrode. Strong and durable. Not affected by temperature extremes. Ideal for industrial, mining, construction, and other sites where rescue operations may call for unusual ruggedness and stability in stretcher equipment. Two-piece patient restraints permit rescuers to easily change positions of straps to fit each individual patient. International Orange. *Stores easily using.*

STANDARD FEATURES

- Molded-in runners and handholds.
- Non-absorbent foam pad secured to stretcher bottom.
- Four quick-release patient restraints.
- Brass grommets for easy bridle attachment.

SPECIFICATIONS

Length	85" (216 cm)
Width	24" (61 cm)
Height	7½" (20 cm)
Weight	27 lbs. (12 kg)
Load capacity	600 lbs. (273 kg)



Ferno Model 71-S Two-Piece Basket Stretcher

Separates in half for easy storage in outside compartments or interior cabinets. Excellent for backpacking rescue operations. *Stores easily using.*

STANDARD FEATURES

- Strong, durable polyethylene shell.
- Sturdy, lightweight aluminum frame.
- Separates in half for more compact storage.
- Non-absorbent foam pad secured to each section bottom.
- Four quick-release patient restraints.

SPECIFICATIONS

Length (use)	85¼" (217 cm)
Length (storage)	43¼" (110 cm)
Width	24¼" (62 cm)
Height	7¾" (20 cm)
Weight	31 lbs. (14 kg)
Load capacity	600 lbs. (273 kg)

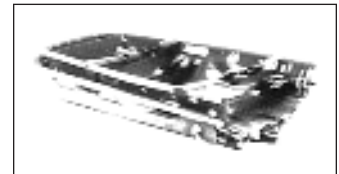

Ferno Model 71-M Mining Basket Stretcher

Model 71 design adapted for mining use with plastic-covered aluminum frame fastened with plastic rivets. Low conductivity. Excellent for use in subway tunnels and mining sites. Wide wood runners help the stretcher slide easily over rough terrain. Velcro® closures on all restraints. *Stores easily using.*

SPECIFICATIONS

Length	85" (216 cm)
Width	24" (61 cm)
Height	8¼" (20 cm)
Weight	31 lbs. (14 kg)
Load capacity	600 lbs. (273 kg)



Splinting Equipment

Ferno Model 71-TS Trail Sled Basket Stretcher

Designed to be towed behind snowmobile or tractor. Tow bar attaches easily to basket stretcher frame with quick-release pins. Tow bar sits above basket stretcher and does not interfere with movement of the basket stretcher over hills or moguls.

SPECIFICATIONS

Length	85" (216 cm)
Width	24" (61 cm)
Height	8 ¹ / ₄ " (20 cm)
Weight	31 lbs. (14 kg)
Load capacity	600 lbs. (273 kg)

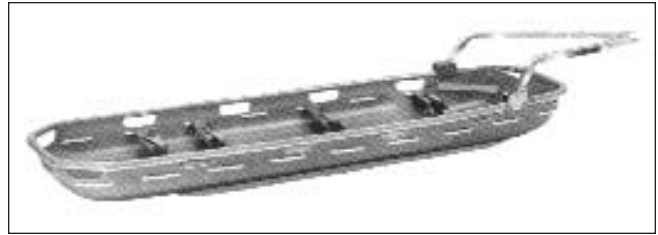

Ferno Model 71-SP Ski Patrol Basket Stretcher

Rescue toboggan with towing handles for ski patrol rescue. Towing-handle frame can be easily removed for storage. Rescuer has control of speed with simple chain brake. Second rescuer can use foot-end tow line for guidance. Metal runners attach to underside of basket stretcher. *Stores easily using Model 559 Wall Brackets.*

SPECIFICATIONS

Length	85" (216 cm)
Width	24" (61 cm)
Height	8 ¹ / ₄ " (20 cm)
Weight	31 lbs. (14 kg)
Load capacity	600 lbs. (273 kg)

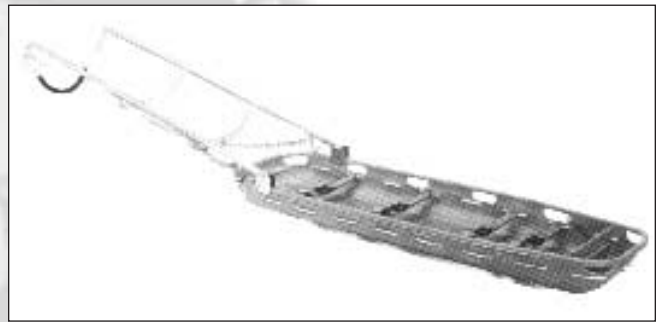

Ferno Model 71-C Combination Basket Stretcher

Includes split feature of 71-S and tow bar of 71-TS as well as towing-handle frame of 71-SP.

Ferno Model 418-1 Lifting Bridle

Locking carabiners quickly attach to lifting points on the Model 71 Basket Stretcher. Welded-in retaining bar within carabiners prevents separation from webbing harness. Both sides of bridle are adjustable to desired angle. Lifting ring has separate opening for harness webbing to reduce damage or abrasion by tow hooks, lifting chains, steel cable, etc. Can be ordered separately. Storage pouch included.



Ferno Model 513-4 Basket stretcher I.V. Pole

Adjustable-height aluminum I.V. pole clamps onto basket stretcher directly above any handhold. Accommodates two I.V. bags or bottles. I.V. fluids are stabilized by Velcro® straps. Pole folds down in the stretcher when not needed.



Splinting Equipment

Ferno Models 387-A, 387-B Carrying/Wall Case for Model 71, 71-S

Vinyl-coated nylon cover protects basket stretcher.
International Orange.

Order Model 387-A for use with Model 71.

Order Model 387-B for use with Model 71-S.

Specify "Emergency Stretcher" lettering if desired.



Ferno Models 445 Universal Head Immobilizer

Unlike other head immobilization devices, the Model 445 Universal Head Immobilizer conforms to any type of wooden or aluminum long backboard as well as the trough-shaped scoop stretcher. (15" width to 20" width.) Eliminates the hassle of heavy sandbags and adhesive tape. And new ear holes allow EMT's to monitor possible bleeding. High-density foam head pads are comfortable and supportive. The vinyl covering makes it easy to clean and maintain.

STANDARD FEATURES

- Only 2 lbs. 4 oz. (0.9 kg).
- No metal hooks or buckles to interfere with X-rays.
- Easy to clean and keep in service.
- Can be used with or without chin strap.
- Available in International Orange.

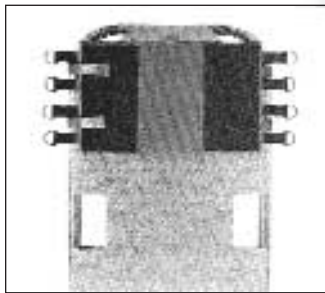
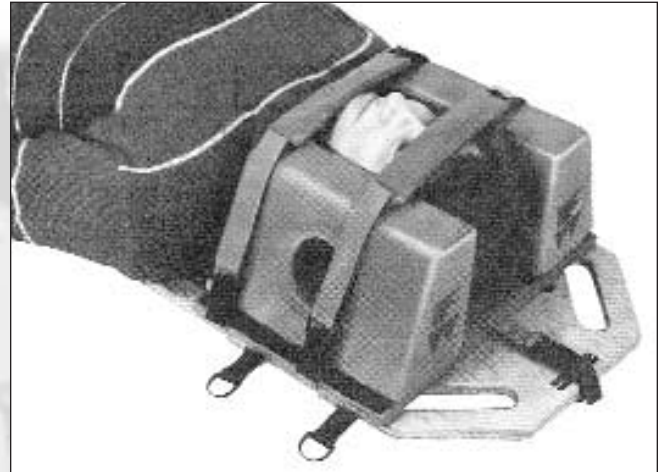

Fits both wood and aluminum boards. Base can be left on during storage.

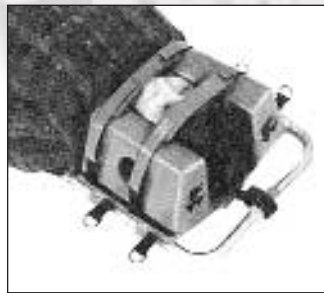

Three-panel base plate conforms to scoop stretcher. Angled foam pads are reversible for best fit.



Separate head support pads allow attendants to immobilize patient with angulated neck injury in position found.



Universal Head Immobilizer is compact for easy storage. 10" L x 15 1/2" W x 6" H (25 cm x 39 cm x 15 cm).

Ferno Models 365 Head Restraint

For use with orthopedic scoop stretchers. Allows fixation of head in the position found. Forehead restraint attaches to top and side frame of stretcher. Supportive side head pillows constructed of high-density foam. Velcro® fastener strips included.

STANDARD FEATURES

- Easy application.
- No chin strap necessary.
- Easy to clean and keep in service.

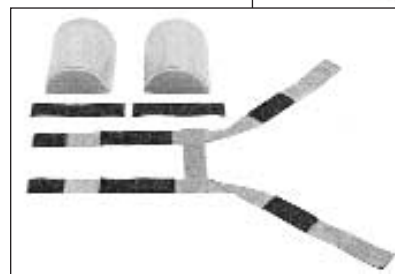
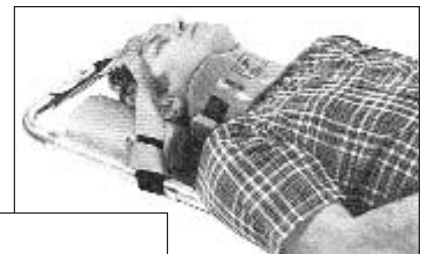

Kit includes head support pads, forehead restraint strap, and Velcro® strips.